

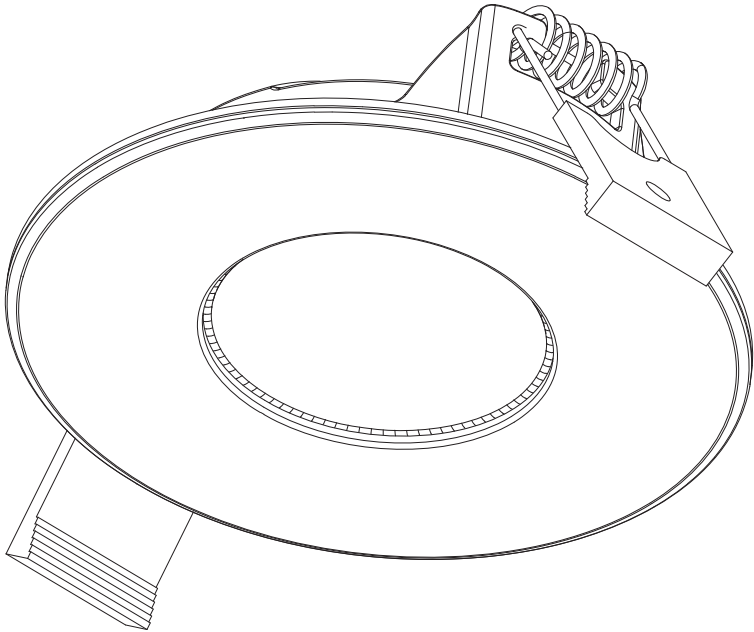









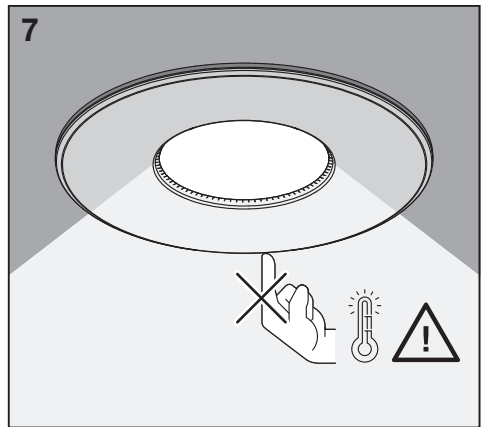
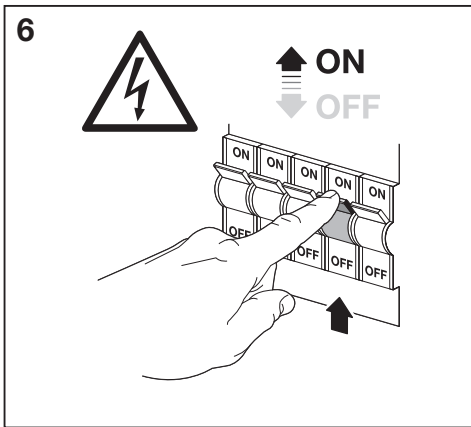
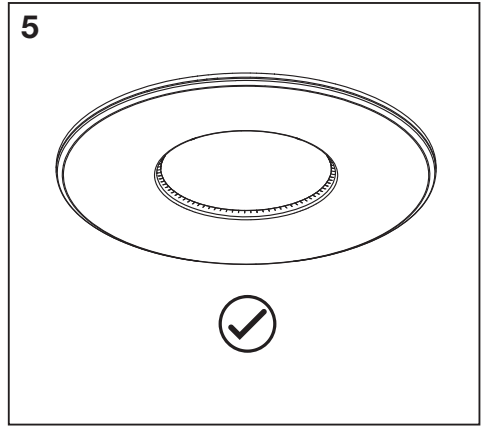
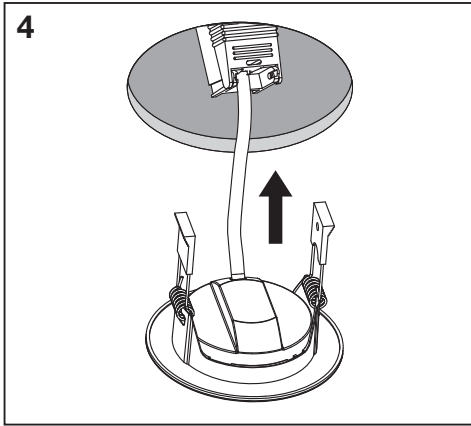

























SPOT SET 3X 4.9W

























































	EAN	W	lm light source	lm output	K	Θ_{amb} (°C)	V~	mA	Hz	PF	φ (°)	
SPOT SET 4.9W 82736DEG SN	4099854595417	4.9	420	270	2700	-20... +40	220- 240	40	50/60	0.4	36	15000
SPOT SET 4.9W 827 36DEG WT	4099854595493	4.9	420	280	2700	-20... +40	220- 240	40	50/60	0.4	36	15000
SPOT SET 4.9W 827 120DEG SN	4099854595516	4.9	420	200	2700	-20... +40	220- 240	40	50/60	0.4	120	15000
SPOT SET 4.9W 827 120DEG WT	4099854595530	4.9	420	220	2700	-20... +40	220- 240	40	50/60	0.4	120	15000









					
EAN		n		 QR code	ENERGY * X =
SPOT SET 4.9W 82736DEG SN	4099854595417	3	AC87594		F
SPOT SET 4.9W 827 36DEG WT	4099854595493				
SPOT SET 4.9W 827 120DEG SN	4099854595516				
SPOT SET 4.9W 827 120DEG WT	4099854595530				









*  Dieses Produkt enthält eine Lichtquelle der Energieeffizienzklasse <X>.  This product contains a light source of energy efficiency class <X>.  Ce produit contient une source lumineuse de classe d'efficacité énergétique <X>.  Questo prodotto contiene una sorgente luminosa di classe di efficienza energetica <X>.  Este producto contiene una fuente luminosa de la clase de eficiencia energética <X>.  Este produto contém uma fonte de luz da classe de eficiência energética <X>.  Το προϊόν αυτό περιέχει φωτεινή πηγή της τάξης ενεργειακής απόδοσης <X>.  Dit product bevat een lichtbron van energie-efficiëntieklasse <X>.  Denna produkt innehåller en ljuskälla med energieeffektivitetsklass <X>.  Tämä tuote sisältää valonlähteen, jonka energiatehokkuusluokka on <X>.  Dette produktet inneholder en lyskilde med energieffektivitetsklasse <X>.  Dette produkt indeholder en lyskilde i energieffektivitetsklasse <X>.  Tento výrobek obsahuje světelný zdroj s třídou energetické účinnosti <X>.  Данный продукт содержит энергосберегающий источник света (класса <X>).  Tämä tuote sisältää valonlähteen, jonka energiatehokkuusluokka on <X>.  Ez a termék egy <X> energiatékozságsági osztályú fényforrást tartalmaz.  Ten produkt zawiera źródło światła o klasie efektywności energetycznej <X>.  Tento výrobok obsahuje svetelný zdroj triedy energetickej účinnosti <X>.  Ta izdelek vsebuje svetlobni vir razreda energetske učinkovitosti <X>.  Bu ürün, enerji verimliliği sınıfında bir ışık kaynağı içerir <X>.  Ovaj proizvod sadržava izvor svetlosti klase energetske učinkovitosti <X>.  Acest produs conține o sursă de lumină cu classa de eficiență energetică <X>.  Tozi produkt včlova svetlinou izotčnik s klas na energijnia efektivnost <X>.  Toode sisaldab energiatõhususe klassi <X> valgusallikat.  Šiame gaminyje yra šviesos šaltinis, kurio energijos vartojimo efektyvumo klasė <X>.  Šis s ražojums satur gaismas avotu, kura energoefektivitātes klase ir <X>.  Ovaj proizvod sadrži izvor svetlosti klase energetske efikasnosti <X>.  Цей виріб містить джерело світла класу енергоефективності <X>.  Бул енимде <X> энергия тиімділігі класының жарық көзі бар.





**  Eignung der Wand/Decke prüfen. Wenn Sie sich nicht sicher sind, lassen Sie sich beraten  Vérifiez l'adéquation du mur/plafond. En cas d'incertitude, demandez conseil à un professionnel  Controllare l'idoneità della parete o del soffitto. In caso di dubbi, consultare un professionista  Compruebe la idoneidad de la pared o techo. Si no está seguro, busque asesoramiento profesional  Verifique a adequação da parede/teto. Se não tiver a certeza, procure aconselhamento profissional  Ελέγξτε τον τοίχο/την οροφή ως προς την καταλληλότητα. Σε περίπτωση αμφιβολίας, ζητήστε επαγγελματική συμβουλή  Controleer wand/plafond op geschiktheid. Als u niet zeker bent, vraag dan professioneel advies  Kontrollera vägg/tak för lämplighet. Om du är osäker, sök professionell rådgivning  Tarkista seinän/katon sopivuus. Jos olet epävarma, kysy neuvoa ammattilaiselta  Sjekk om veggen/taket egner seg. Oppsøk profesjonell rådgivning dersom du er usikker  Kontroller væg/loft for egnethed. Hvis du er usikker, skal du søge professionel rådgivning  Zkontrolujte vhodnost stěny/stropu. Pokud si nejste jisti, vyhledejte odbornou radu  Проверьте стену/потолок на пригодность. Если у вас есть сомнения, обратитесь за профессиональной консультацией  Elle-nõrize a fal/mennejze te alkalmasságát. Ha bizonytalan, kérjen szakszertű tanácsot  Sprawdź, czy ściana/pufoc nadają się do montażu. W razie wątpliwości zasięgnij porady wykwalifikowanej osoby  Skontrolujte vhodnost steny/stropu. Ak si nie ste istí, vyhľadajte odbornú pomoc  Preverite primernost stene/stropa. Če niste prepričani, poiščite nasvet strokovnjaka  Duvann/tavanni uygun olup olmadığını kontrol edin. Emin değilseniz uzman bir kişiden destek alın  Proverite prikladnost zida/stropa. Ako niste sigurni, potražite stručni savjet  Verificati dacă peretele/tavanul este adecvat. În caz de incertitudine, solicitați consultanță de specialitate  Проверете прогодността на стената/тавана. Ако не сте сигурни, потърсете професионален съвет  Kontrolli seinale/lakke sobivust. Kahtluse korral küsi professionaalilt nõu  Patrinkite sienos/lubų tinkamumą. Jei kyla abejonų, kreipkitės į specialistą  Pārbaudiet sienu/griestu piemērotību. Neskadīrbu gadjūmā meklējiet profesionālu padomu  Proverite pogodnost zida/plafona. Ako niste sigurni, potražite stručni savet  Перевірте відповідність стіни/стелі. Якщо ви не впевнені, зверніться за професійною консультацією  Қабырғаны/тебенің жарамдылығы тексеріңіз. Егер сенімді болмасаңыз, кәсіби кенеске жүгініңіз





***  Schnellverbinder mit Durchgangsverdrahtungsoption.  Connecteur rapide avec option de câblage traversant.  Connettore rapido con opzione di cablaggio passante.  Conector rápido con opción de cableado pasante.  Conector rápido com opção de cablagem contínua.  Γρήγορος σύνδεσμος με δυνατότητα άμεσου περάσματος.  Snelle verbinder met doorbedradingsoptie.  Snabbkoppling med möjlighet till kabelgenomföring.  Pikalittini, jossa on läpivahdotusvaihtoehto.  Hurtigkobling med mulighed for gennemgående ledning.  Hurtigkobling med mulighed for gennemgående ledningsføring.  Rychlospojzka s možností průchozího zapojení.  Быстрый разъем с возможностью сквозного подключения.  Gyrusatslakozó átméni kábelvezéssel.  Szybkozłączka z możliwością okablowania przelotowego.  Rychlý konektor s možností přechozího zapojení.  Hitri priključek z možnostjo ožičenja.  Geçişli kablolama imkânı sunan hızlı konektör.  Brzi priključak s mogućnošću provlačenja žica.  Conector rapid cu opțiune de cablare directă.  Konektor za brzo svързане с опция за директно окабеляване.  Kiriühendus koos läbivahutimise võimalusega.  Greito prijungimo jungtis su laidų parinktimi.  Ātrais savienotājs ar opciju savt elektronstālāciju.  Brzi konektor sa opcijom sprowańczenia oczynena.  Konektor švidgogo montażu z możliwością naszkriego przewożenia kablowo.  Өткізгіш арқылы қосу мүмкіндігі бар жылдам қосқыш.









Cet appareil se recycle
 À DÉPOSER EN MAGASIN
 OU
 À DÉPOSER EN DÉCHÈTERIE

Points de collecte sur www.quefairedemesdechets.fr

G11235860
17.10.2025



LEDVANCE SASU
 CQM, 5 rue d'Altorf
 67120 Molsheim France
www.ledvance.com

LEDVANCE Ltd, Sterling House,
 810 Mandarin Court, Warrington,
 Cheshire, WA1 1GG, United Kingdom