

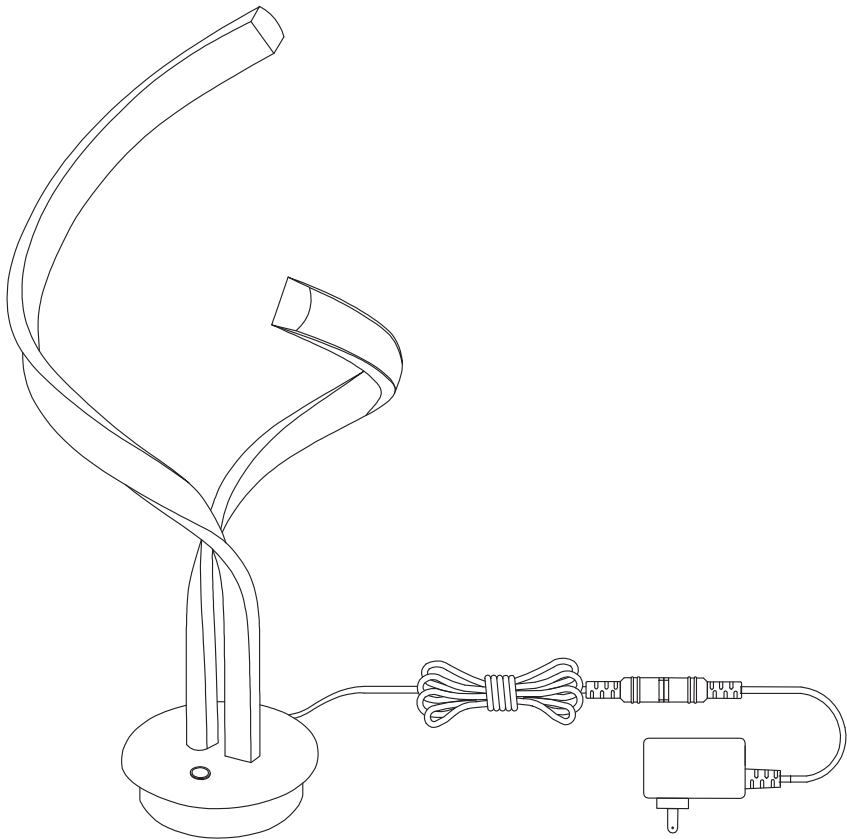









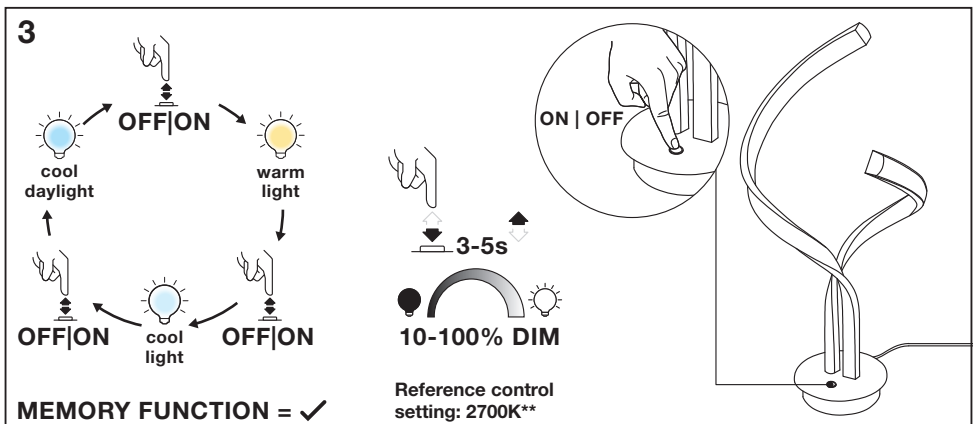
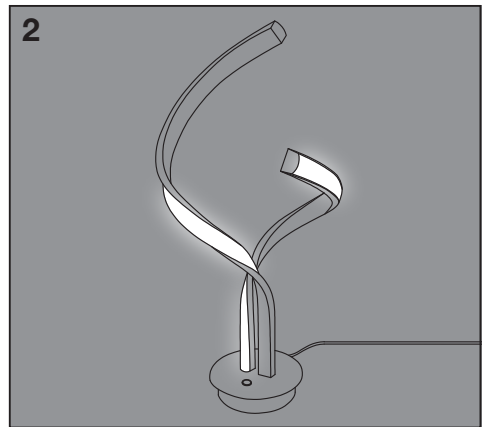
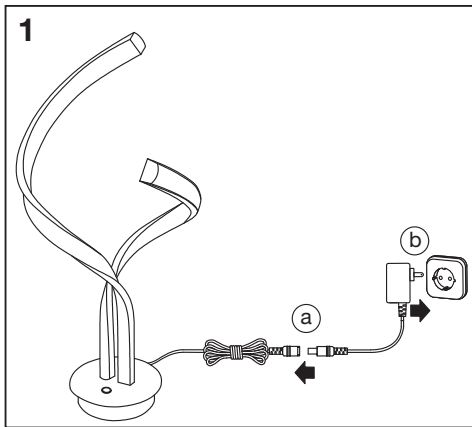
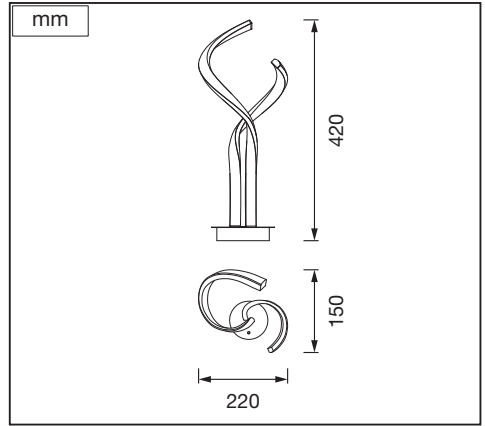
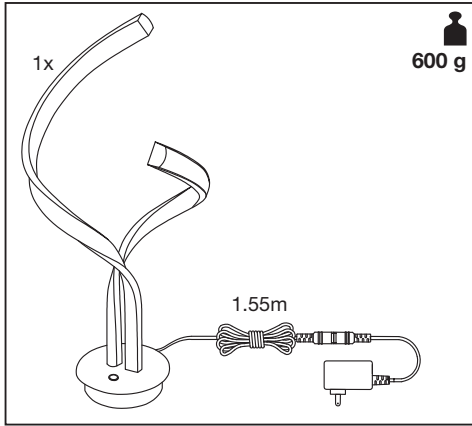























DECOR STRINGY TABLE



























	EAN	W	lm light source	lm output	K	°C	V~	mA	Hz	DF	PF	▽ (°)	
DECOR STRINGY TABLE 12W CCT WT	4058075856905	12	1060 @4000K	800 @4000K	2700/ 4000/ 6500	-20...+40	220-240	85	50/60	>0.7	>0.5	270	12500



				
	EAN	n		 QR code
				ENERGY * X =
DECOR STRINGY TABLE 12W CCT WT	4058075856905	37	AC90771	 F

*  Dieses Produkt enthält eine Lichtquelle der Energieeffizienzklasse <X>.  This product contains a light source of energy efficiency class <X>.  Ce produit contient une source lumineuse de classe d'efficacité énergétique <X>.  Questo prodotto contiene una sorgente luminosa di classe di efficienza energetica <X>.  Este producto contiene una fuente luminosa de la clase de eficiencia energética <X>.  Este produto contém uma fonte de luz da classe de eficiência energética <X>.  Το προϊόν αυτό περιέχει φωτεινή πηγή της τάξης ενεργειακής απόδοσης <X>.  Dit product bevat een lichtbron van energie-efficiëntieklasse <X>.  Denna produkt innehåller en ljuskälla med energieffektivitetsklass <X>.  Tämä tuote sisältää valonlähteen, jonka energiatehokkuusluokka on <X>.  Dette produktet inneholder en lyskilde med energieffektivitetsklasse <X>.  Dette produkt indeholder en lyskilde i energieffektivitetsklasse <X>.  Tento výrobek obsahuje světelný zdroj s třídou energetické účinnosti <X>.  Данный продукт содержит энергосберегающий источник света (класса <X>).  Ez a termék egy <X> energiatékonysági osztályú fényforrást tartalmaz.  Ten produkt zawiera źródło światła o klasie efektywności energetycznej <X>.  Tento výrobek obsahuje svetelný zdroj triedy energetickej účinnosti <X>.  Ta izdelek vsebuje svetlobni vir razreda enerjske učinkovitosti <X>.  Bu ürün, enerji verimliliği sınıfında bir ışık kaynağı içerir <X>.  Ovaj proizvod sadržiava izvor svetlosti klase energetske učinkovitosti <X>.  Acest produs conține o sursă de lumină cu clasa de eficiență energetică <X>.  Този продукт включва светлинен източник с клас на енергийна ефективност <X>.  Toode sisaldab energiatõhususe klassi <X> valgusallikat.  Siame gaminyje yra šviesos šaltinis, kurio energijos vartojimo efektyvumo klasė <X>.  Ši s ražojums satur gaismas avotu, kura energoefektivitātes klase ir <X>.  Ovaj proizvod sadrži izvor svetlosti klase energetske efikasnosti <X>.  Цей виріб містить джерело світла класу енергоефективності <X>.  Бул өнімде <X> энергия тиімділігі класының жарық көзі бар.

**  Referenzkontrollinstellung  Réglage de la commande de référence  Impostazione controllo di riferimento  Configuración de control de referencia  Configuração de controlo de referência  Ρύθμιση χειρισμού αναφοράς  Referentiesturingsinstelling  Inställning för referenskontroll  Vertailuasetus  Referansekontrollinstilling  Referenckontrolinstilling  Nastavení referenčního ovládaní  Referencia vezérlés beállítás  Ustawienie kontroli wartości odniesienia  Nastavenie referenčného ovládania  Nastavitev referenčnega nadzora  Referans kontrol ayarı  Referentna kontrolna postavka  Setare control de referință  Настройка на референтния контрол  Vordluskontrolli seadistus  Etaloninio valdymo nustatymas  Atsauces vadības iestatījums  Postavka kontrole reference  Налаштування еталонного контролю



RECICLA
Al Azul



22
PAP
Raccolla Carta
Verifica le disposizioni
del tuo comune.



FR















FR

Cet appareil et
ses accessoires
se recyclent

À DÉPOSER
EN MAGASIN

OU

À DÉPOSER
EN DÉCHÈTRIE

Points de collecte sur www.quefairedemesdechets.fr



LEDVANCE SASU
CQM, 5 rue d'Altorf
67120 Molsheim France
www.ledvance.com

 LEDVANCE Ltd, Sterling House,
810 Mandarin Court, Warrington,
Cheshire, WA1 1GG, United Kingdom

G11252148
11.12.2025