

PHILIPS

Fyns

9290047047



User manual
Benutzerhandbuch
Notice d'emploi
Manual de usuario
Manual do usuário
Manuale d'uso
Gebruiksaanwijzing

Incl.

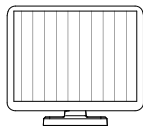
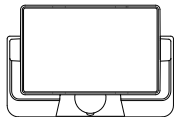

Excl.

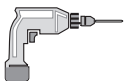

09



13



36

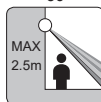

37

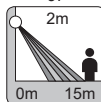

38

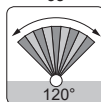

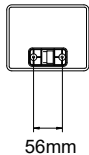
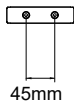
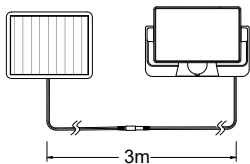

1

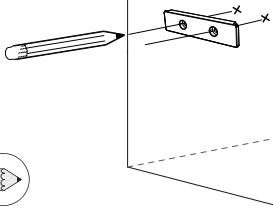

2

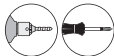
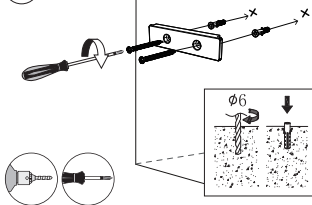

3

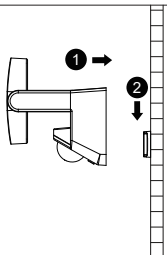

4

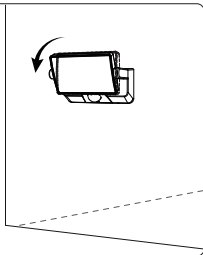

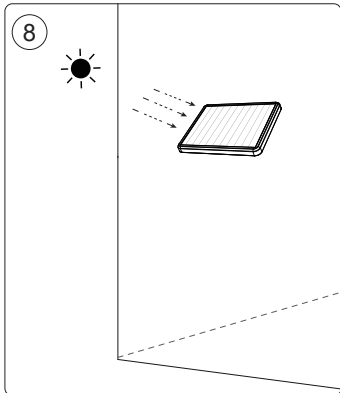
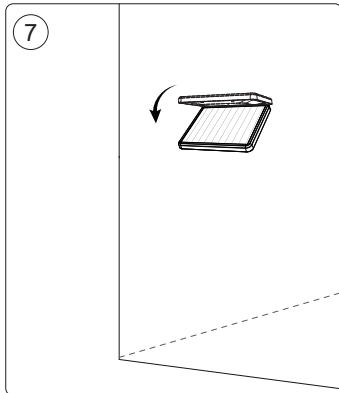
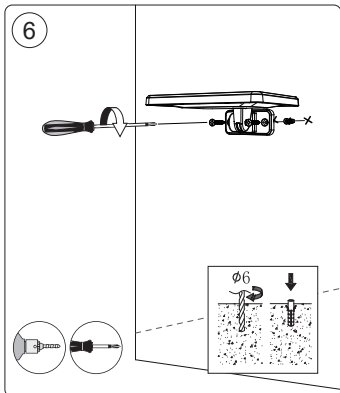
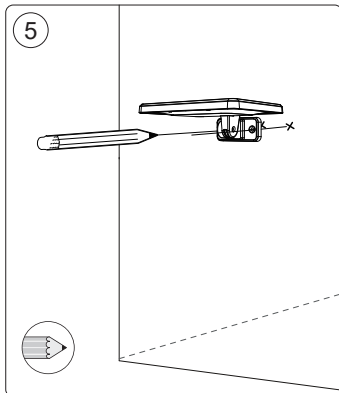

9

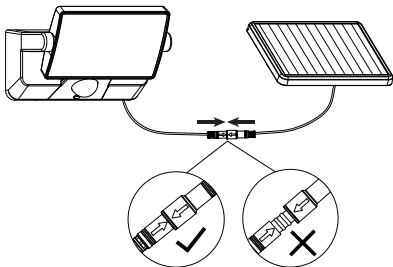
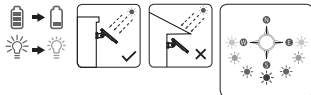

10

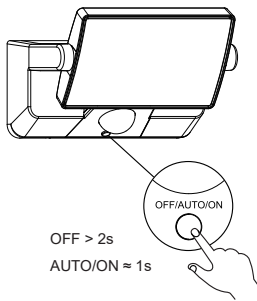

OFF/AUTO/ON 	 OFF	 OFF	 OFF
OFF/AUTO/ON 	 3S	 OFF	 ON
OFF/AUTO/ON 	 3S	 ON	 ON
	 10H	 OFF	 ON

Replace Battery

1

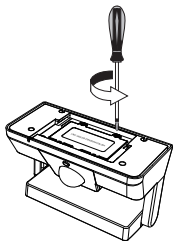

2

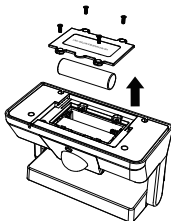

3

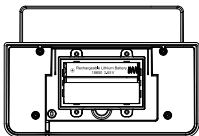

18650/3.6-3.7V Li-ion/Min2600mAh

4

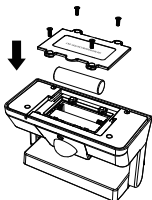

5

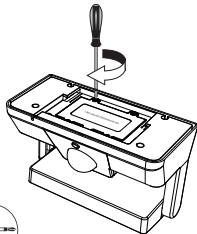



Signify Commercial UK Limited
2 Guildford Business Park,
GU2 8XG

Signify
I.B.R.S. / C.C.R.I. Numéro 10461
5600 VB Eindhoven,
the Netherlands
☎00800-74454775

©2025 Signify Holding

 **signify**

Philips and the Philips Shield Emblem
are registered trademarks of Koninklijke
Philips N.V. and are used under license

www.philips.com/lighting

3241 663 01961